

SUBMITTAL/TECHNICAL DATA SHEET



DESCRIPTION

Non-Rated Recessed Access Door provides access through openings in vertical or horizontal surfaces. This door is designed to receive 5/8 inch drywall to match the surrounding surfaces.

FEATURES

- Recessed Pan Door
- Custom Sizing

SPECIFICATIONS

MODEL: BRA/BRW/BRP

DOOR: 16 gauge Steel

FRAME: 16 gauge Steel

SIZE:

Minimum: 8 inches by 8 inches

Maximum: 24 inches by 36 inches

INSTALLATION: Ceiling

FLANGE: None, Drywall Bead or Plaster Bead

LATCH: Screwdriver Cam Latch, Key Operated Cam Lock or Mortise Lock Prep

HINGE: Concealed pivoting rod

PAN DEPTH: 5/8 inch

FINISH: White Powder Coat

OPTIONS: Flanges, Latches, Gaskets

WARRANTY: 1 year



SKU: **B RAC**

RECESSED ACCESS DOOR

DIMENSIONS AND APPEARANCE

>> CLICK TO VIEW ADDITIONAL DETAILS AND PRICING <<

ORDER GUIDE:

BASE	FLANGE	LATCH	WIDTH	X	LENGTH	OPTIONS
BR						
	A No Flange	C Screwdriver Cam Latch	STANDARD SIZES (W X L)			B Galvannealed
	P Plaster Bead	L Key operated Cam Lock	8" X 8"	20"	30"*	S Type 304 Stainless Steel
	W Drywall Bead	M Mortise Lock (1-1/8") Prep	12" X 12"	24"	24"*	
			16" X 16"	24"	30"*	
			18" X 18"	24"	36"*	

Rough opening is door size + 1/4 inch minimum. Additional sizes available, call for more information.
*Ceiling application only.

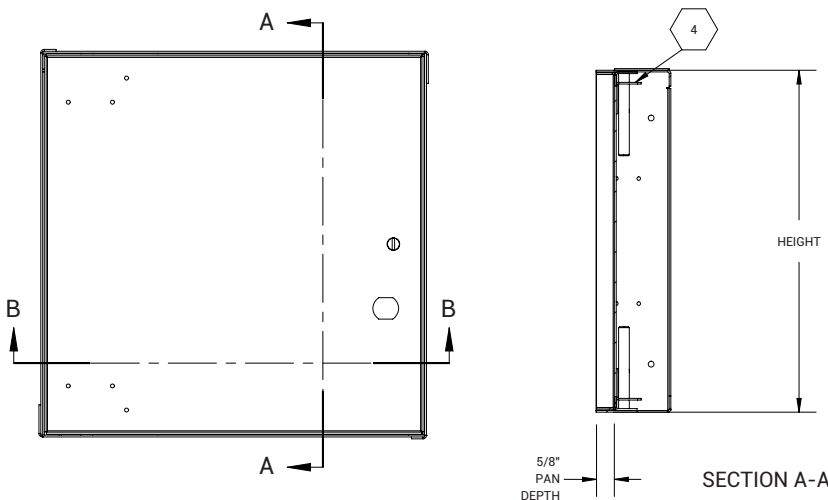



FOR DETAILED SPECIFICATIONS
SEE SUBMITTAL SHEET

PROJECT DATA

Custom Sizes Available - Fast!

PROJECT NAME :	QTY	W	H	OPTIONS
ARCHITECT :				
DEALER :				
CONTRACTOR :				
LOCATION :	SPECIAL INSTRUCTIONS :			
DATE :	SUBMITTAL APPROVAL : (signature or stamp)			
TAGGING INSTRUCTIONS :				

Scan  or  Click



To view Pricing and
Additional Product Info.

TELEPHONE:
1-888-457-1275
FAX:
1-888-626-2907



PO BOX 66738 #76520,
SAINT LOUIS, MO
63166-6738
USA



WEBSITE:
www.AccessDoorsAndPanels.com
E-MAIL:
info@AccessDoorsAndPanels.com



B RAC

RECESSED ACCESS DOOR

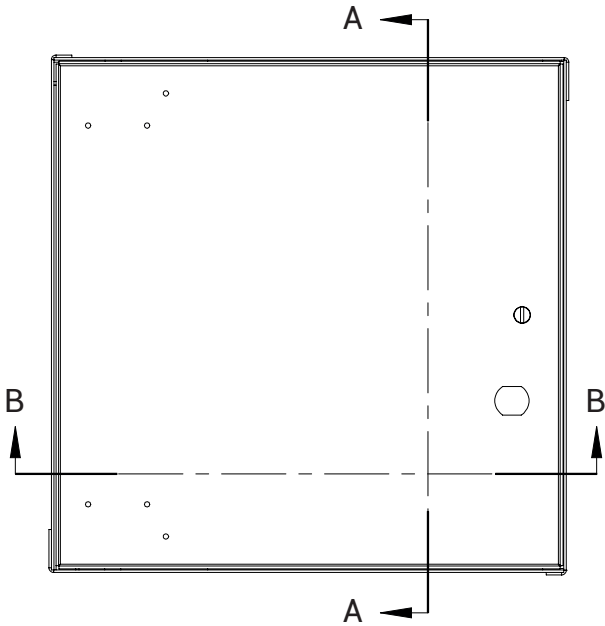

NOTES:

- ① FRAME:
- ② DOOR: Cold Rolled Steel, 16 ga
- ③ FINISH: White Powder Coat
- ④ HINGE: Concealed Rod Hinge
- ⑤ LATCH:

OPTIONS:

- Masonry Anchors (M)
- Gasket Installed (G)

ROUGH OPENING: $W + 0.25" \times H + 0.25"$
 CLEAR OPENING: $W - 1.5" \times H - 0.125"$
 DEGREE OF OPENING: 100°
 CAM QTY: N/A LATCH SIDE
 N/A TOP/BOTTOM SIDE

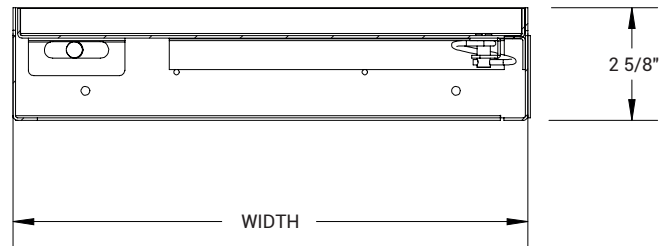

SECTION B-B

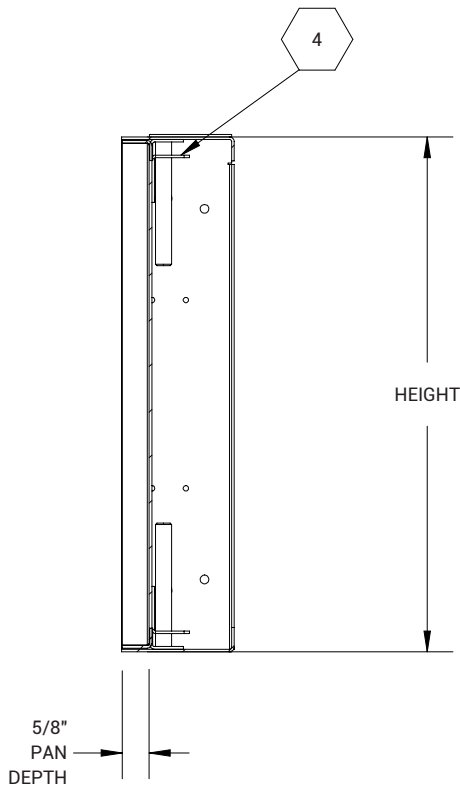

SECTION A-A

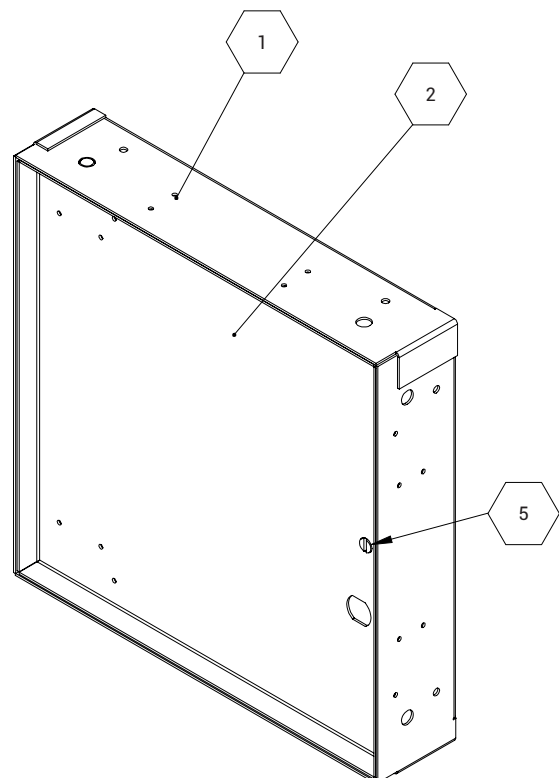



B RAC

RECESSED ACCESS DOOR

